

Rev No.	Description	Date	Name
A	New Part	05/05/2003	A.Vismara

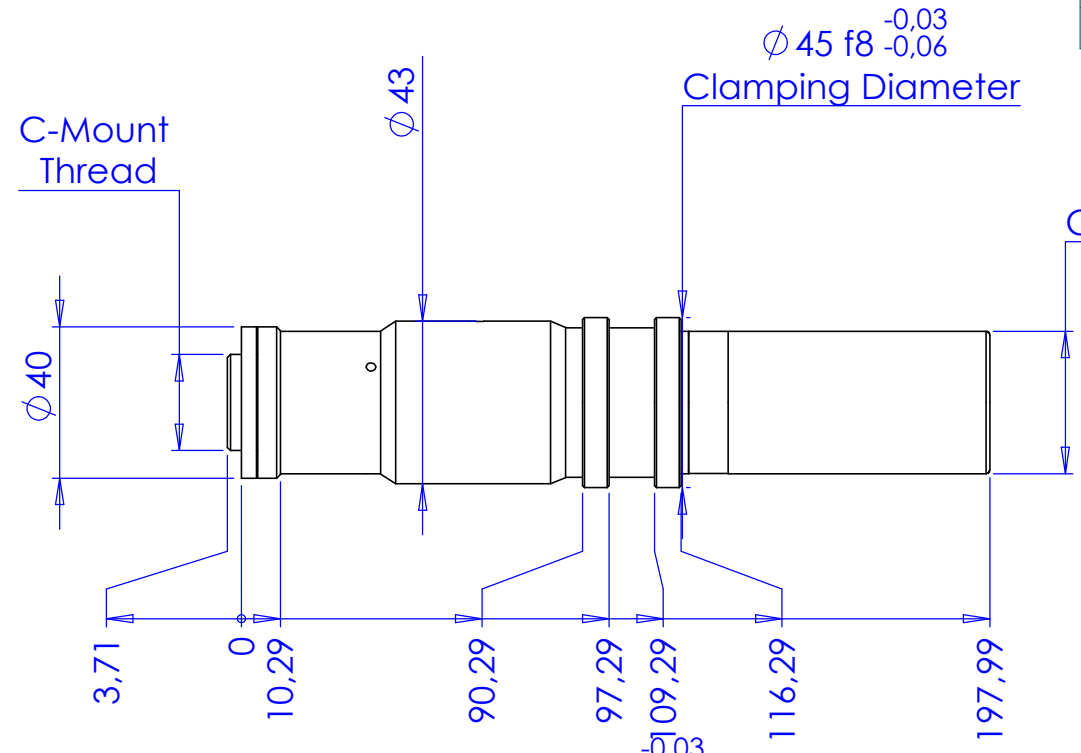

TC 2M 16/C
C-Mount

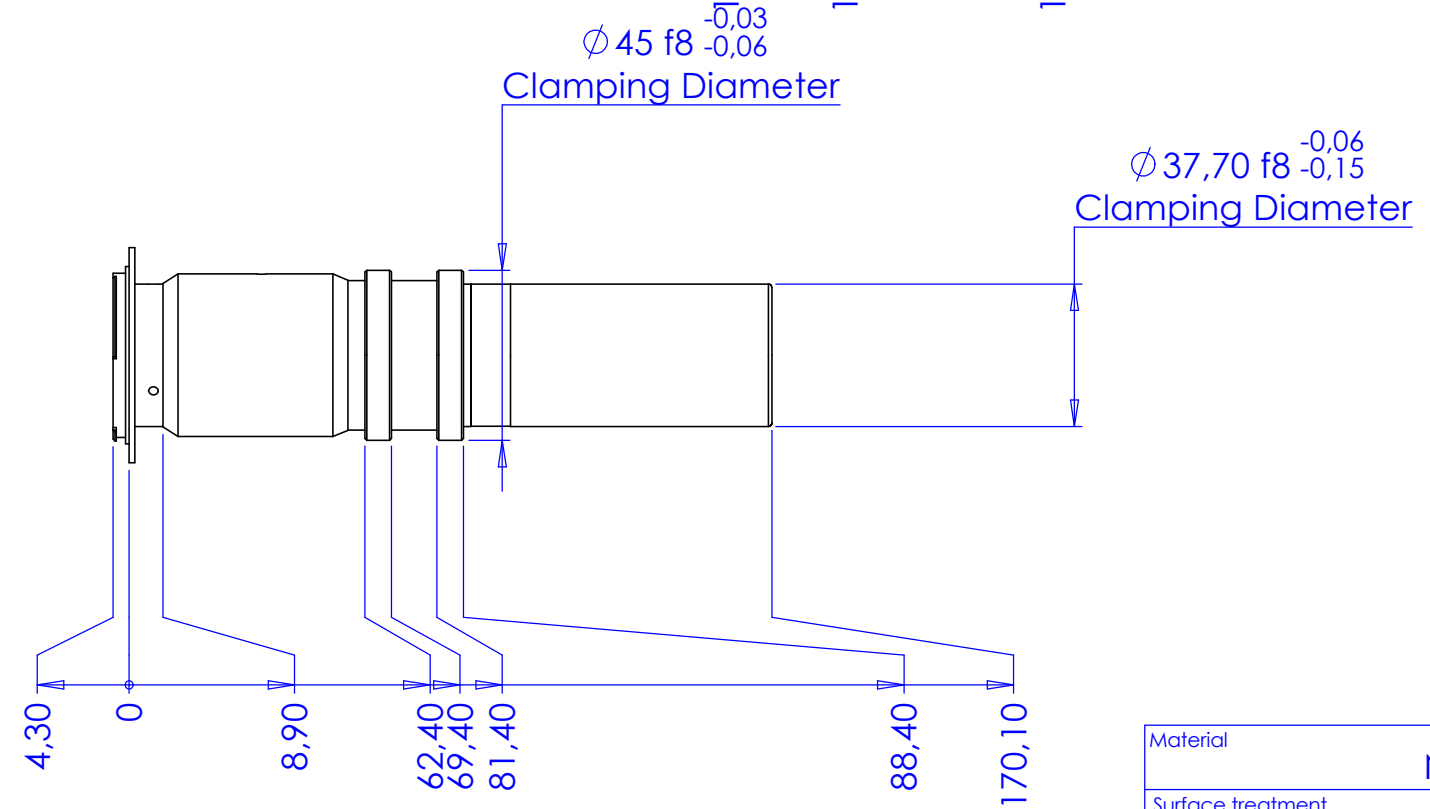

TC 2M 16/F
F-Mount

Material	N.A.			Mass	261 g	Scale	1:2	
Surface treatment	N.A.			Project-Prod.item/Instrument		TC 2M 16		
Geometrical tolerance (ISO 2768-2)			Class	K	Description			
Linear tolerance (ISO 2768-2)			Class	m	Undimensioned bevels	0.5x45°	Layout	
0.5	>3±	>6±	>30±	>120	>400±	>1000		Undimensioned radii
±3	6	30	120	±400	1000	±2000	R 0.5	
±0.1	±0.1	±0.2	±0.3	±0.5	±0.8	±1.2	±2	
			Date	Name	Drawing No.			
			Designed	17/07/2006	A.Vismara	21582-0-A		Sheet
			Draw	17/07/2006	A.Vismara			1/1
			Checked	X	C. Sedazzari	Reproduction forbidden without specific authorization		
OPTO ENGINEERING S.r.l. - 46100 Mantova Italy - Via Cremona, 29/2 - Tel. +39 0376 263525 - e-mai: info@opto-engineering.com - http://www.opto-engineering.com								